

The history of revision change for the specification

| Document      | REV. | Modified date | Description   |
|---------------|------|---------------|---|
| CYNVC-223-054 | A0   | 2022.3.28     | New approval  |
| CYNVC-223-054 | A1   | 2022.6.19     | 1. Mar -> Jun<br>2. Update Outline Dimensions figure<br>3. Update Marking figure<br>4. Update Tape Direction figure   |
| CYNVC-223-054 | A2   | 2022.7.22     | 1. Jun -> Jul<br>2. Update Tape packaging dimensions figure<br>3. Update Dimensions Code<br>A0: $6.35 \pm 0.10$ -> $6.30 \pm 0.10$<br>B0 $6.35 \pm 0.10$ -> $6.30 \pm 0.10$ |
| CYNVC-223-054 | A3   | 2022.8.11     | 1. Jul -> Aug<br>2. Update outline dimensions T: $4.5 + 0.2 / - 0.3$ -> $4.5 \pm 0.2$   |
| CYNVC-223-054 | A4   | 2022.11.11    | 1. Aug → Nov<br>2. Update 2R2 Rdc Typ/Max: $25.0/30.0$ -> $18.0/21.6$<br>3. Update 2R2 Idc Typ/Max: $5.2/4.42$ -> $5.53/5.05$   |
| CYNVC-223-054 | A5   | 2023.3.29     | 1. Nov., 2022 -> Mar., 2023<br>2. Update 101 Isat Typ/Max: $1.2/1.0$ -> $1.4/1.2$<br>3. Update UNITS/REEL : 500 -> 1500   |
| CYNVC-223-054 | A6   | 2024.2.21     | 1. Mar., 2023 -> Feb., 2024<br>2. Add spec of 3R3, 6R8, 8R2, 150, 330, 470, 680, 331<br>3. Update curve of 2R2, 4R7   |

### Power Choke Coil VCGA064G MS5 type

AEC-Q200

#### ■ Features

Low profile : Thickness max. 4.7mm  
 Low loss realized with low DCR  
 Compliance with RoHS and Halogen Free  
 AEC-Q200 qualified

#### ■ Application

Automotive applications

#### ■ Outline Dimensions

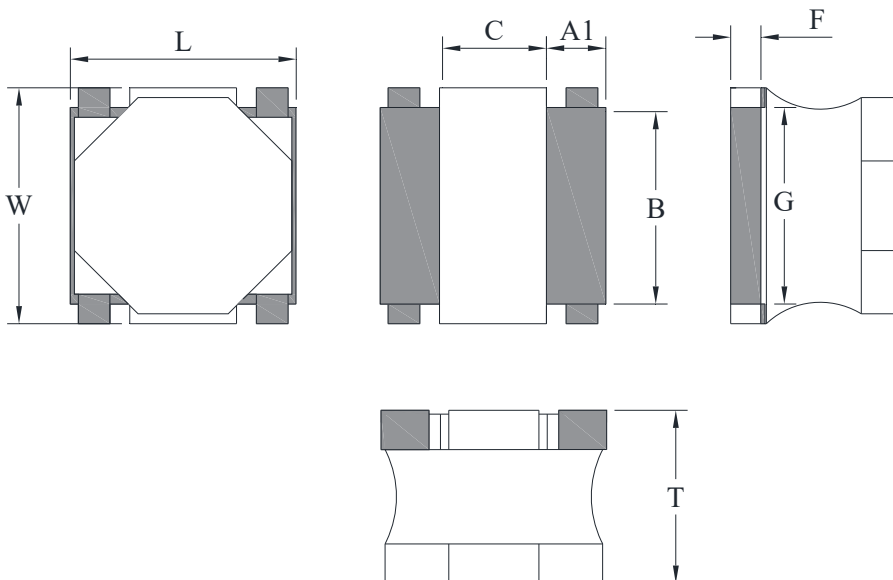

| Code | Dimensions (mm) |
|------|-----------------|
| L    | 6.0 ± 0.2       |
| W    | 6.0 ± 0.2       |
| T    | 4.5 ± 0.2       |
| A1   | 1.8 ± 0.3       |
| B    | 5.0 Typ.        |
| C    | 2.4 Typ.        |
| F    | 0.3 Min.        |
| G    | 5.0 ± 0.2       |

#### ■ Recommend Land Pattern Dimensions

The customer shall determine the land dimensions shown below after confirming and safety.

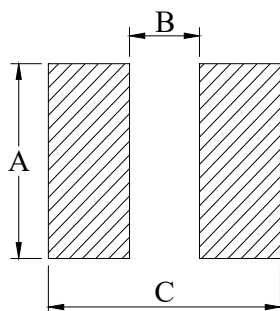

|   |     |
|---|-----|
| A | 5.1 |
| B | 1.9 |
| C | 6.3 |

Unit : mm

■ **Marking**

The inductor is marked with a 3-digit code

Example -- 2.2 $\mu$ H → 2R2

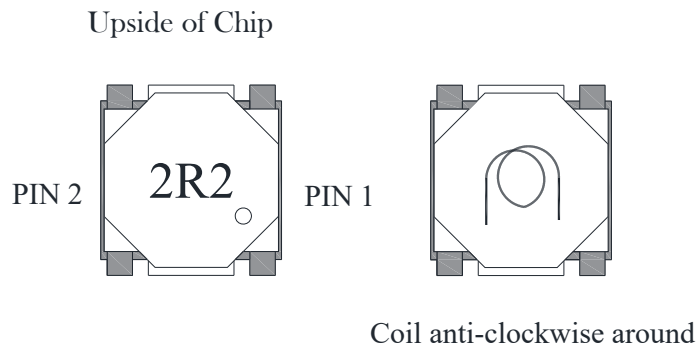

### ■ Specifications

| Part Number     | L0 ◇<br>Inductance<br>( $\mu$ H)<br>@ (0A) | R <sub>dc</sub> (m $\Omega$ ) ◇ |         | Heat Rating Current<br>DC Amps. I <sub>dc</sub> (A) |         | Saturation Current<br>DC Amps. I <sub>sat</sub> (A) |         |
|-----------------|--|---------------------------------|---------|---|---------|---|---------|
|                 |  | Typical                         | Maximum | Typical   | Maximum | Typical   | Maximum |
| VCGA064G-1R0MS5 | 1.0  | 9.0                             | 10.8    | 7.80  | 6.63    | 14.4  | 12.0    |
| VCGA064G-2R2MS5 | 2.2  | 18.0                            | 21.6    | 5.53  | 5.05    | 10.0  | 8.6     |
| VCGA064G-3R3MS5 | 3.3  | 22.0                            | 26.4    | 5.44  | 4.96    | 7.82  | 6.70    |
| VCGA064G-4R7MS5 | 4.7  | 35.0                            | 42.0    | 3.95  | 3.36    | 7.0   | 5.8     |
| VCGA064G-6R8MS5 | 6.8  | 38.7                            | 46.5    | 3.70  | 3.33    | 5.83  | 5.00    |
| VCGA064G-8R2MS5 | 8.2  | 47.0                            | 56.4    | 3.8   | 3.4     | 5.6   | 4.8     |
| VCGA064G-100MS5 | 10.0                                       | 57.0                            | 68.4    | 3.40  | 2.89    | 4.7   | 4.0     |
| VCGA064G-150MS5 | 15.0                                       | 80.5                            | 96.6    | 2.9   | 2.6     | 4.2   | 3.6     |
| VCGA064G-220MS5 | 22.0                                       | 143.0                           | 171.6   | 2.20  | 1.87    | 3.4   | 2.9     |
| VCGA064G-330MS5 | 33.0                                       | 180.0                           | 216.0   | 1.9   | 1.7     | 2.63  | 2.25    |
| VCGA064G-470MS5 | 47.0                                       | 246.0                           | 295.2   | 1.63  | 1.48    | 2.00  | 1.71    |
| VCGA064G-680MS5 | 68.0                                       | 358.0                           | 429.6   | 1.31  | 1.20    | 1.57  | 1.40    |
| VCGA064G-101MS5 | 100.0                                      | 540.0                           | 648.0   | 1.10  | 1.00    | 1.4   | 1.2     |
| VCGA064G-331MS5 | 330.0                                      | 1659.0                          | 1990.0  | 0.57  | 0.51    | 0.8   | 0.67    |

◇ : Significant Characteristic

\* : If you require another part number please contact with us.

\*\* : Inductance Tolerance  $\pm$  20%

Note 1. : All test data is referenced to 25°C ambient.

Note 2. : Test Condition: 100KHz, 1.0Vrms

Note 3. : I<sub>dc</sub> : DC current (A) that will cause an approximate  $\Delta$ T of 40°C

Note 4. : I<sub>sat</sub> : DC current (A) that will cause L0 to drop approximately 30%

Note 5. : Operating Temperature Range -55°C to +155°C

Note 6. : The part temperature (ambient + temp rise) should not exceed 155°C under the worst case operating conditions. Circuit design, component placement, PCB trace size and thickness, airflow and other cooling provision all affect the part temperature. Part temperature should be verified in the end application.

Note 7. : The rated current as listed is either the saturation current or the heating current depending on which value is lower.

Note 8. : Cleaning Process Note

- (a) If this power choke is dipped in the cleaning agent, such as toluene, xylene, ketone, and ether system, there is a possibility that the performance decreases greatly
- (b) The high power ultrasonic washing may damage the choke body.
- (c) Please contact us if you need the cleaning via the above agents or ultrasonic washing.

### Current Characteristic

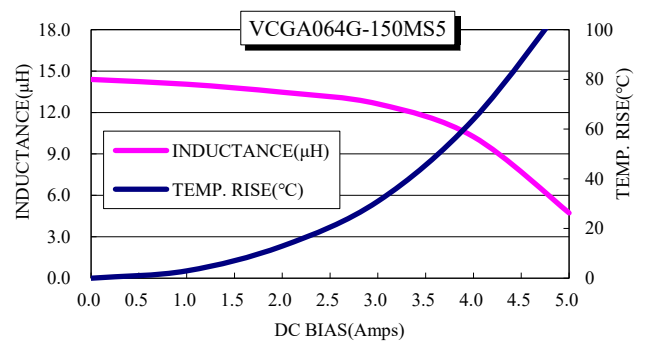
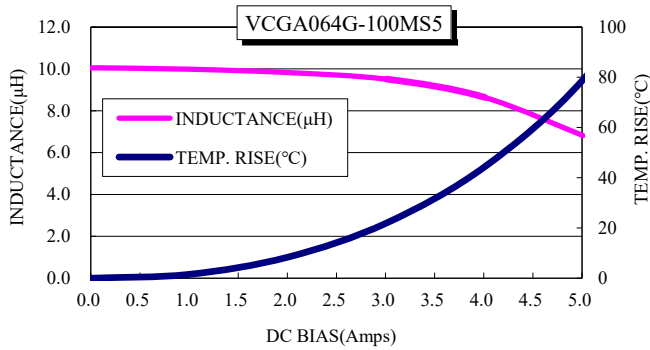
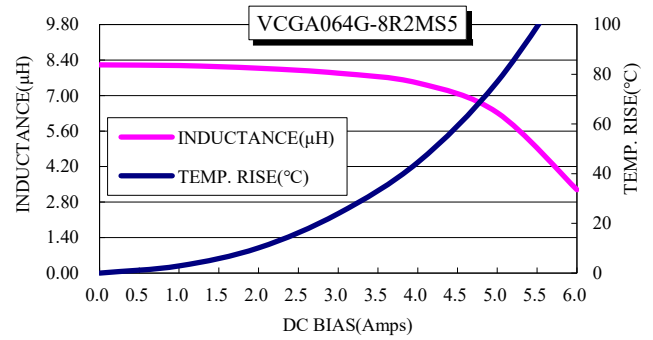
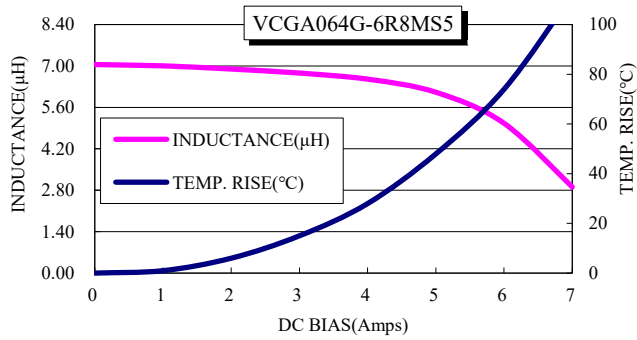
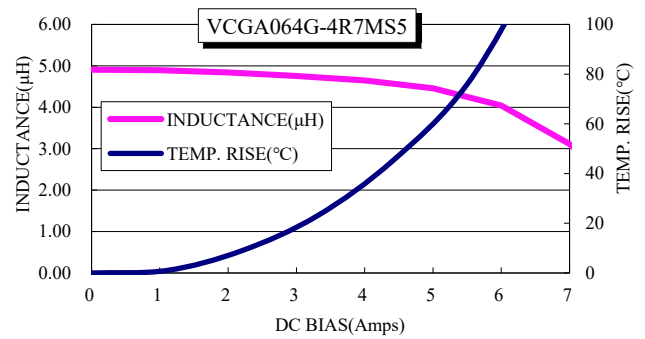
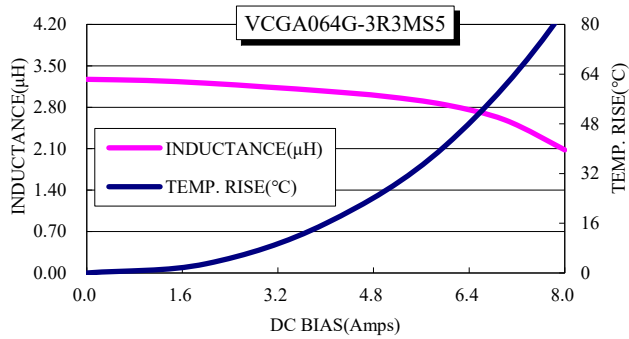
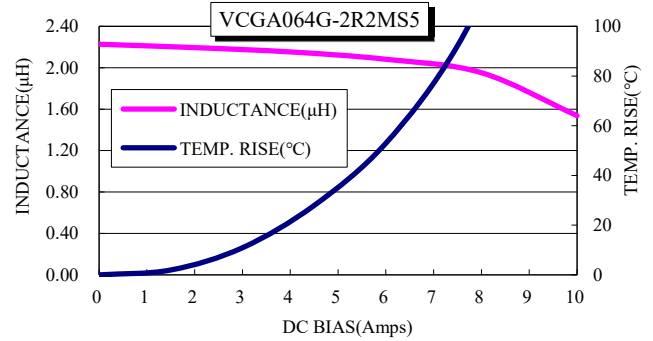
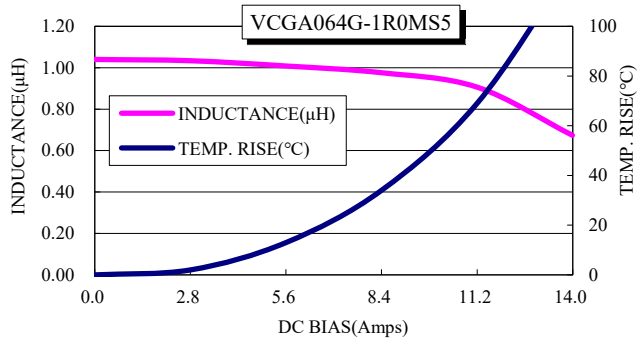

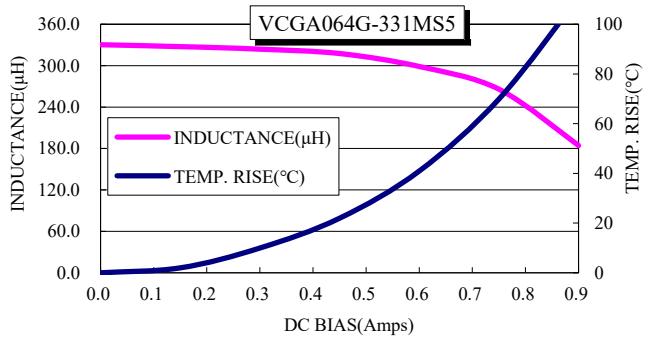
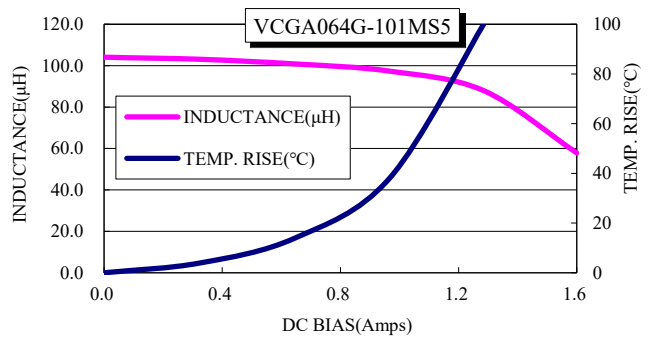
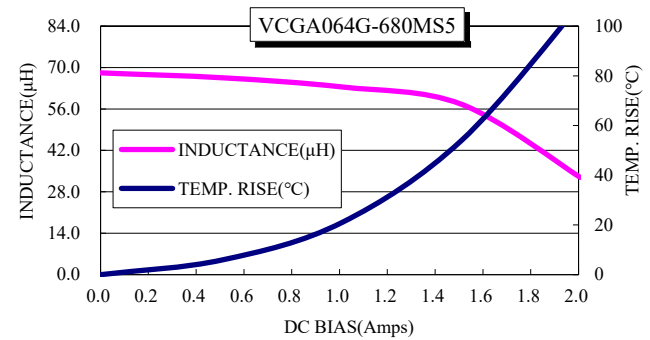
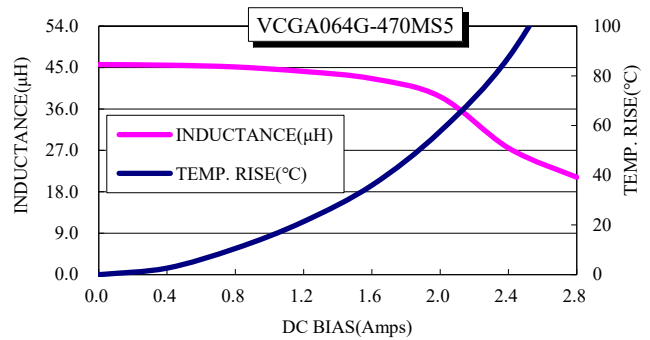
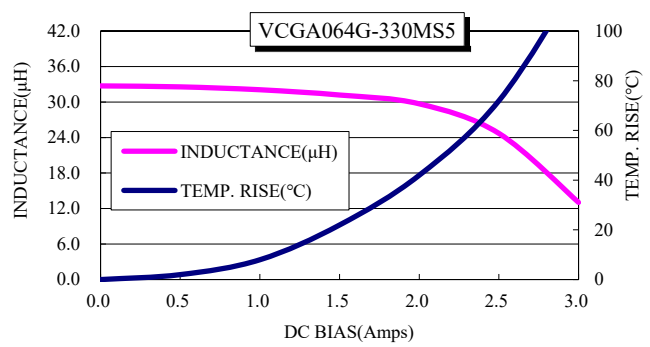
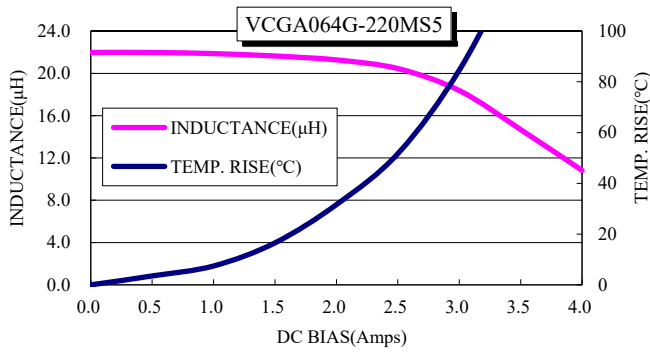

**■ Packaging**

(1) Tape packaging dimensions

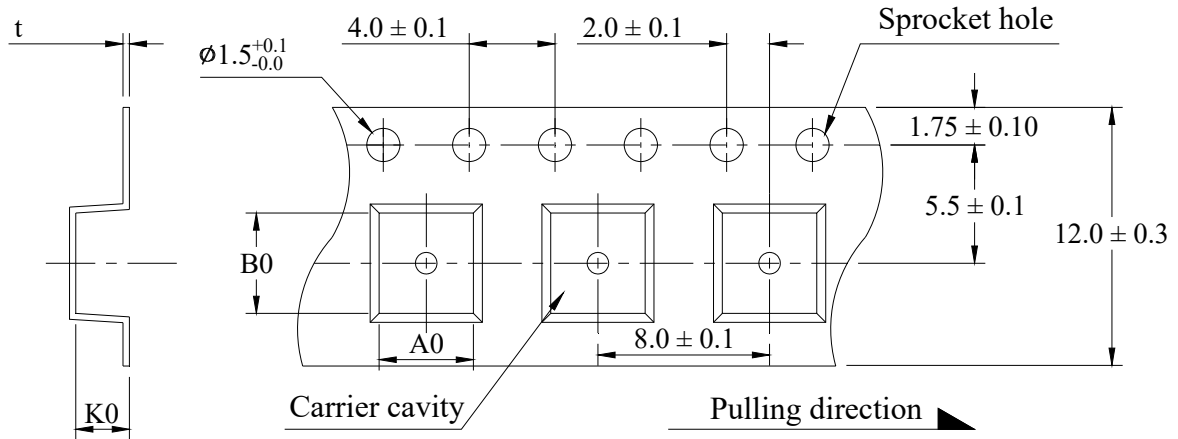

| Dimensions Code (mm) |             |           |             | UNITS/REEL |
|----------------------|-------------|-----------|-------------|------------|
| A0                   | B0          | K0        | t           |            |
| 6.30 ± 0.10          | 6.30 ± 0.10 | 4.9 ± 0.1 | 0.40 ± 0.05 | 1,500      |

(2) Tape direction

The direction shall be seen from the top cover tape side.

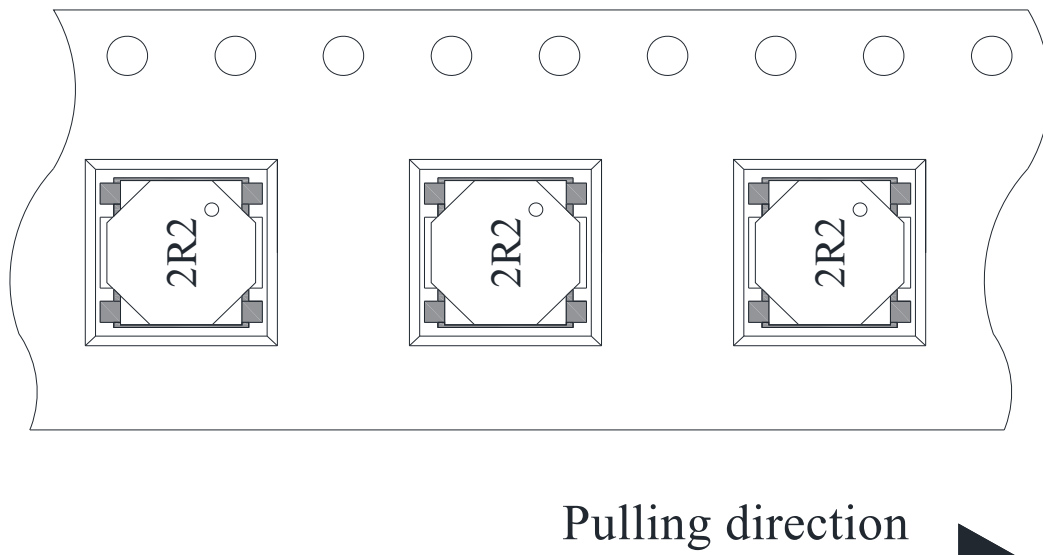

(3) Reel dimensions

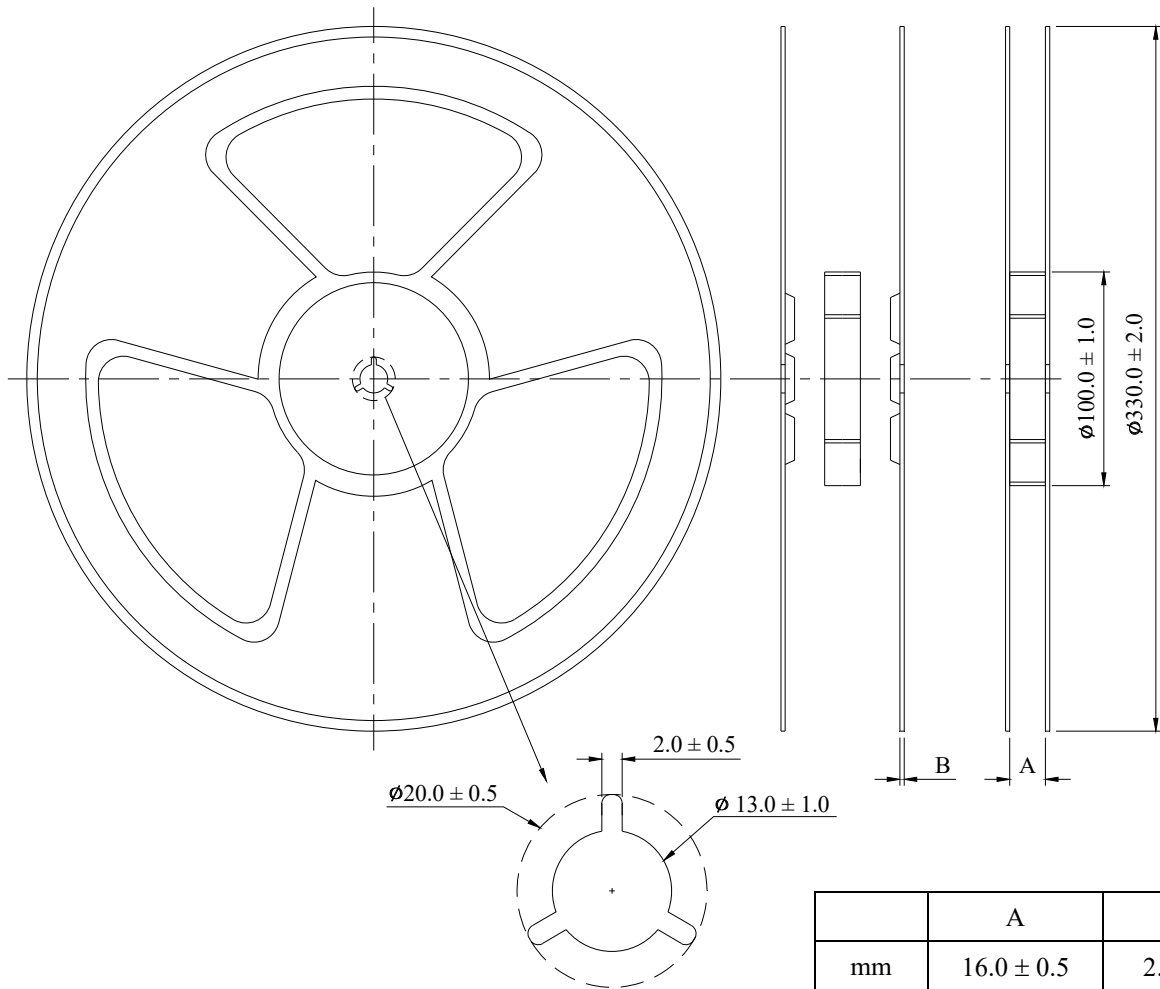

(4) Peel force of top cover tape

The peel speed shall be about 300 mm/minute.

The peel force of top cover tape shall be between 0.1 to 1.3N.

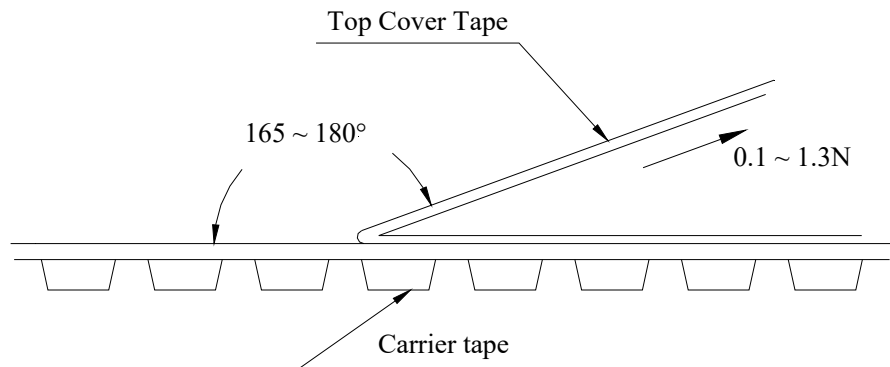



■ Reflow Profile

Power Choke Coil Type

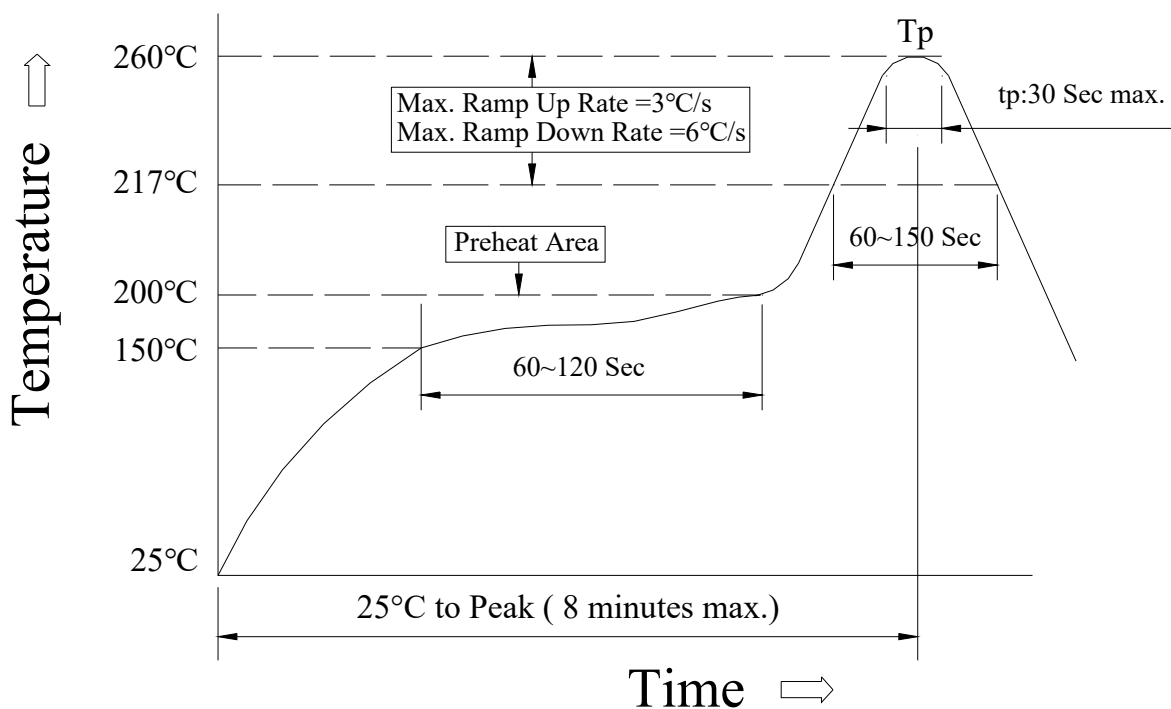

(1) Reflow Soldering Method :

|                               |                |                       |
|-------------------------------|----------------|-----------------------|
| Reflow Soldering              | Tp:255~260°C   | Max.30 seconds ( tp ) |
|                               | 217°C          | 60~150 seconds        |
| Pre-Heat                      | 150 ~ 200°C    | 60~120 seconds        |
| Time 25°C to peak temperature | 8 minutes max. |                       |

(2) Soldering iron Method : 350 ± 5°C max.3 seconds